

# Raphael 707

## Premium Adjusting Table

CATALOG | 2024

*Raphael 707*



**O1M**  
Spine Care System

📺 @01M.international  
📱 YOUNG IL M  
🌐 youngilm.global  
🌐 youngilm.imweb.me

**O1M**  
Spine Care System





# History of Raphael 707

**2023** • The premium adjusting table, Raphael 707-K was released in 2023. With new screen design, the Raphael 707-K provides more accurate, stable and powerful performance.



**2019** • The best selling model 2019 Raphael 707 hit the market. The larger 10" touch screen was designed for comfort and performance.



**2016** • In 2016, the second Raphael 707 came to the world with the modern look and slim design.



**2011** • The first Raphael 707 was developed in 2011, featuring the auto traction, flexion and motrized auto drop for the first in the industry.



# Raphael 707 Premium Adjusting Table

✓ 3D Decompression

✓ Electric Motor Drop

✓ 10" Touch Screen



## Introduction to Screen Features 10" Touch Screen

The Raphael 707-K 10 inch touchscreen controls most of the table's functions. Activating the automatic drops, adjusting the auto flexion/traction and height, saving your desired protocols all happen with a simple touch. The touch screen stand is height adjustable and movable. You don't have to bend your body or knees to use the screen.

✓ Feature

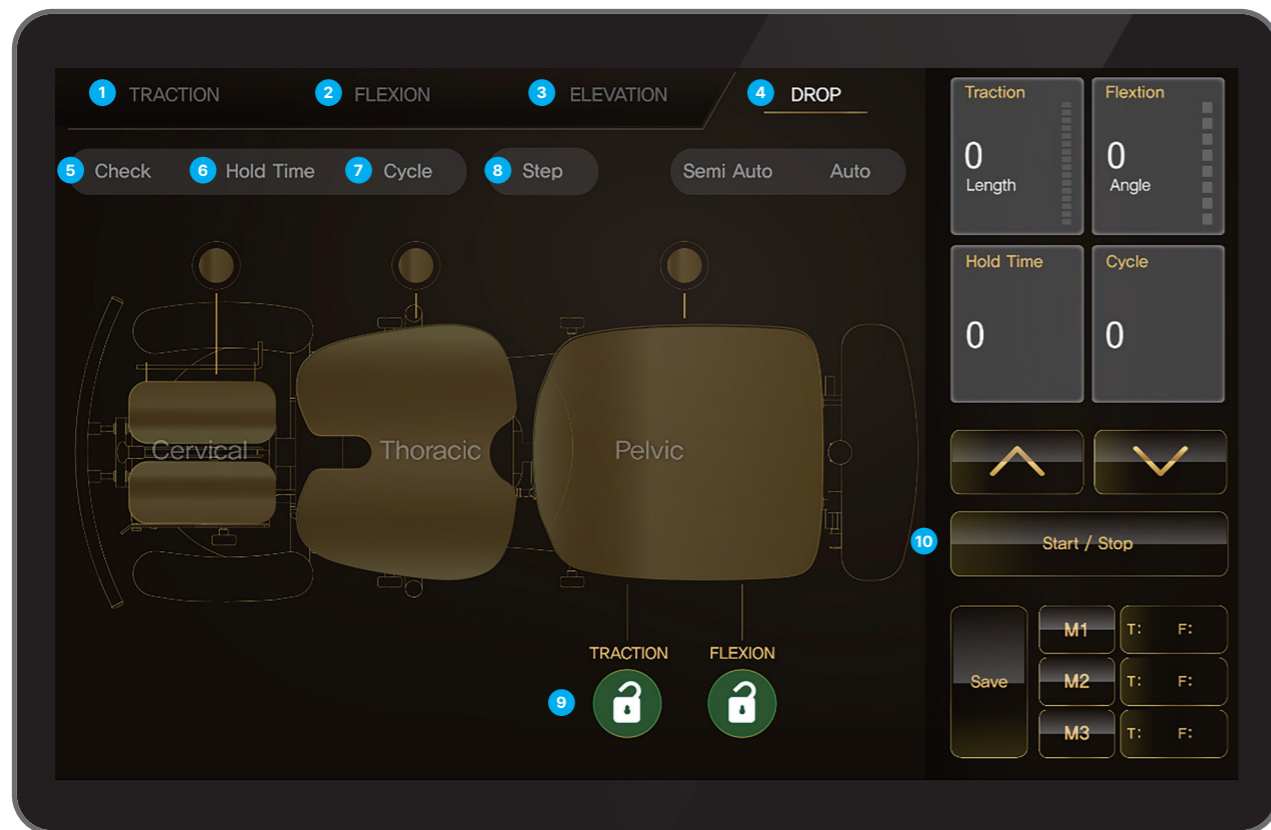

- 1 Traction**  
Adjust the traction distance from 0cm to 10cm(4")
- 2 Flexion**  
Adjust the flexion angle from 0° to 22.4°
- 3 Elevation**  
Adjust the height with one touch
- 4 Drop**  
Activate each drop section and auto / semi auto mode
- 5 Check**  
Activate the flexion or traction immediately to check the patient's tolerance
- 6 Hold Time**  
Set a pausing time (sec.) between each cycle
- 7 Cycle**  
Set a cycle for the auto flexion or traction (max. 30 cycles)
- 8 Step**  
Set an incremental auto flexion or traction
- 9 Lock**  
Lock either traction or flexion during the flexion or traction on
- 10 Save**  
Pre-programme your desired protocol up to 3

## Patented motor design Electric Motor Drop



- The patented motor design offers accurate, smooth and quiet drops.
- No air compressor or hydraulic cylinder is required.
- The self-repetitive technology allows you to use no foot pedal or strip.
- You can focus on your drop adjustment and free your foot.
- It's state of the art technology and superior than other automatic drops on the market.
- The whole drop piece goes down and up regardless of the force being applied on the right, left or center of the cushion.

## Accurate and Effective 3D Decompression



**Axial Traction**

01

The automatic lumbar traction provides up to 10cm(4") axial traction by 16 levels. You can program it and set a pausing time up to 10 seconds between cycles. The axillary rolls, traction harnesses and knee cushion can be used for various patient's positions.



**Auto Flexion**

02

The automatic flexion provides up to 22.4 degrees angle adjustment by 8 levels. The speed of flexion was designed for safe and effective disc treatment. You can program it and set a pausing time up to 10 seconds between cycles. The flexion harness can be used to secure the patient's waist and free your hand.



**Axial Traction + Flexion + Lateral Bending**

03

The human body does not stretch as a stick. The human body stretches in extension, flexion and lateral bending. In 3D decompression, the patient moves. Raphael 707 provides axial traction, flexion and lateral bending. With multiple anchors on the table, it ensures more precision, higher safety and better results.

# Why Raphael 707?

## Dr. Etienne Dubarry

I have been working as a chiropractor in West Palm Beach, Florida for the past 35 years. During my career, I realized that my chiropractic table is certainly the most important tool in of my line of work, obviously, It helps me to treat patient, but more important, it protects me from injuring myself, and as I got older, I increased my reliance on it as many of my colleagues have also done. The main characteristic of such a table is to bring comfort safety protection to patient and doctor as well as drastically improve clinical outcomes.

I saw the Raphael 707 in 2016 for the first time in Florida. I realized at first glance the potential of that table and how it could be a game changer. We had, in a reduced space, a very sophisticated decompression table, not only linear axial decompression but planar decompression. The electronic control allowed the doctor to let his patient unattended freeing him for much needed time. Best of all, the same table could be used to adjust patients. The repetitive self cocking drop was a revelation for the profession. Small doctors could effortlessly treat patient twice their size. This drastic improvement of clinical outcome will probably popularize this feature very quickly.

I am a chiropractor and I believe that any professional using hands-on manual therapy such as of chiropractor, osteopath, or practitioner of chuna will find a great interest in a table that provide such great facilitating tools as those of the Raphael 707.

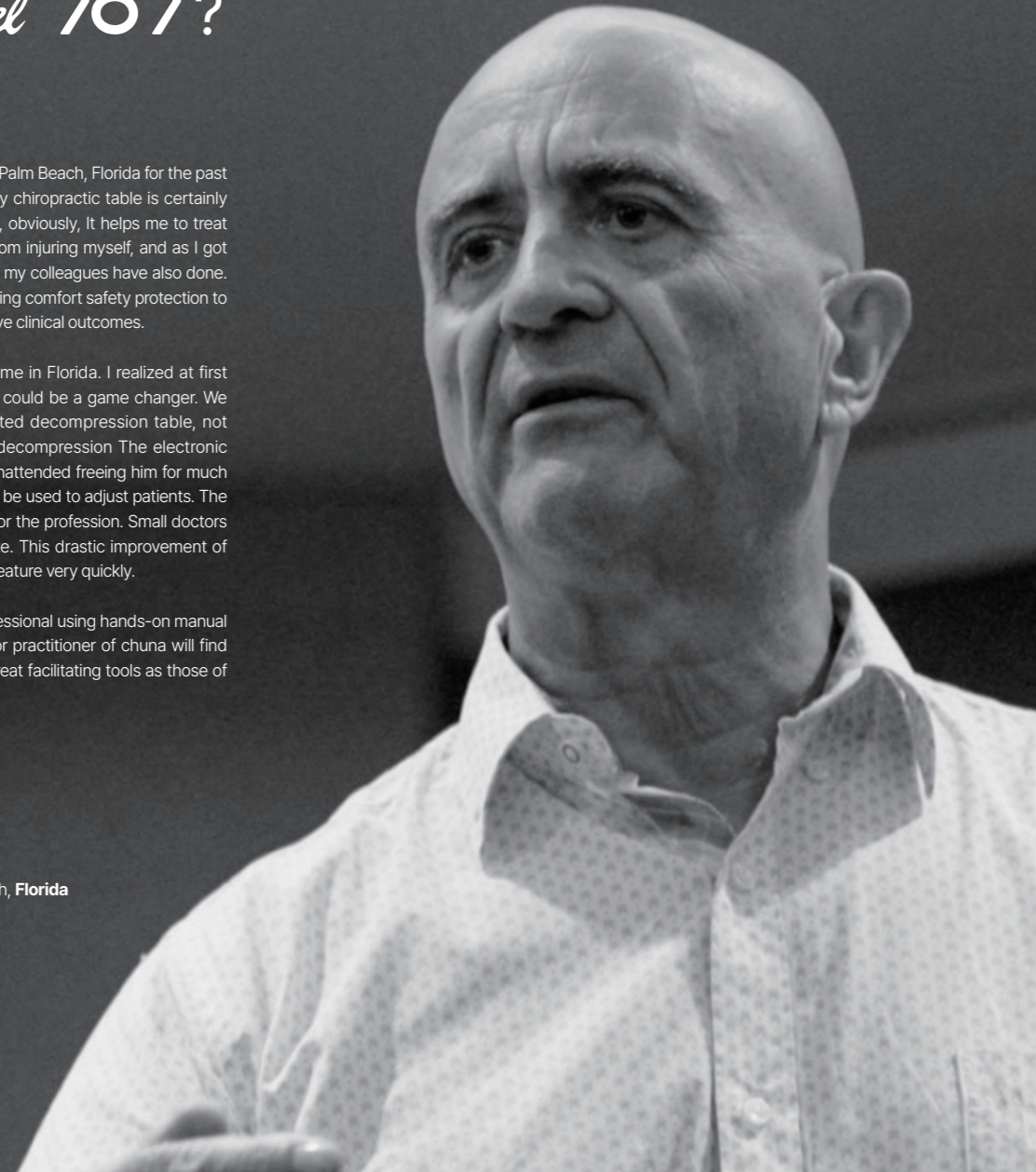
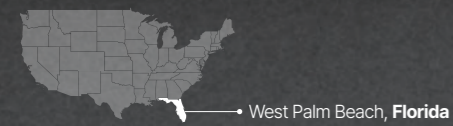

## Raphael Techniques

# Raphael 707 Techniques

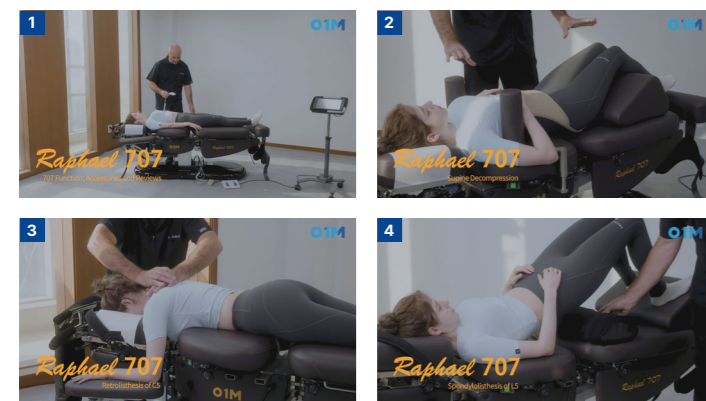

- 1 707 Function, Accessories and Reviews
- 2 Supine Decompression
- 3 Retrolisthesis of C5
- 4 Spondylolisthesis of L5

Check out the Raphael techniques on [O1M Youtube](#) !

## 01M : Raphael 707

# Product Details

## Cushion Color

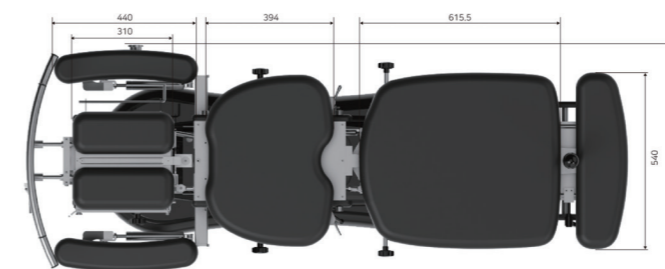
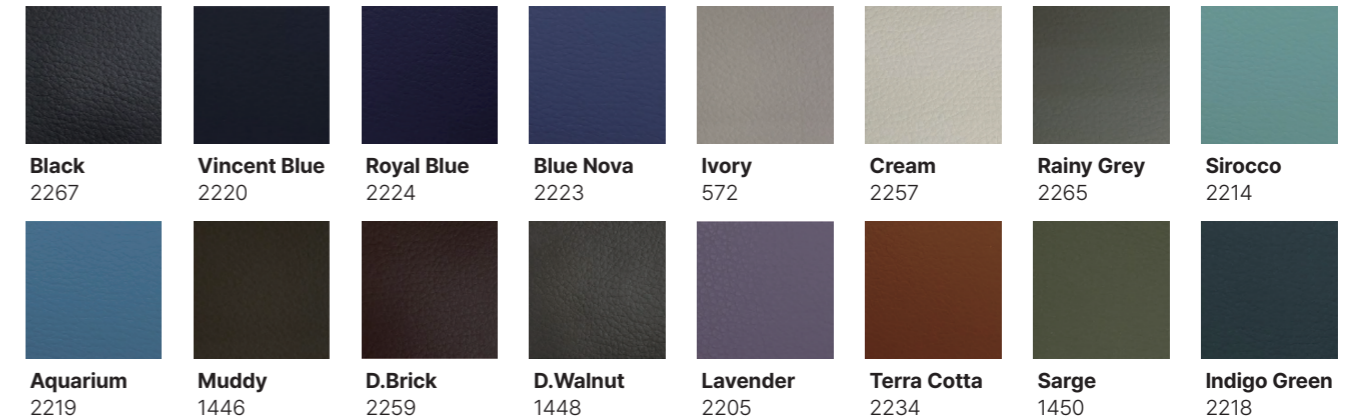

[unit: mm]

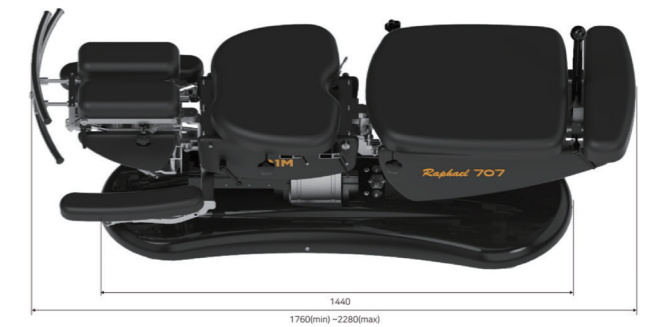

## Standard Features

- **Electric Motor Automatic Drop:** Cervical, Thoracic/Lumbar and Pelvic
- **Automatic Flexion:** 22.4° / 8 levels
- **Automatic Lumbar Traction:** 10cm(4") / 16 levels
- **3 Stage Column Elevation:** 59cm ~ 89cm(23" ~ 35")
- **DP Button:** Adjust height with up/down button
- **Traction Package:** axillary rolls, traction belts and knee cushion
- **Saddle Chair:** matched to your table color
- 10" LCD Touch Screen
- Emergency Stop Button
- Patient Safety Hand Reset Controller
- Headpiece Flexion & Elevation
- Headpiece Lateral Flexion & Circumduction
- Adjustable Hand Grib Bars
- Adjustable armrest
- Magnetic Paper Roll Holder
- Premium Synthetic Leather Cushion
- 2 Foot Pedal: for elevation and semi-auto drop
- Set of Cervical Straps
- Set of Flexion Belts
- Flexion Assistant Handle
- Dutchman Roll

## Specifications

- **Height Range:** 59cm ~ 89cm(23" ~ 35")
- **Length:** 176cm ~ 228cm(69" ~ 90")
- **Width:** 67cm(26")
- **Weight:** 135kg(300lbs)
- **Lifting Capacity:** 180kg(400lbs)
- **Foam:** Medium Density Standard
- **Flexion:** 22.4° / 8 levels
- **Traction:** 10cm(4") / 16 levels
- **Warranty:** 1 Year on All Parts
- **Certifications:** CE MDR, US FDA Registerd, KFDA
- **Duty Cycle:** 10%(2 minute use, 18 minutes rest)

## Optional Features

- Scoliosis Package
- Genuine Leather Cushion

**O1M** Spine Care System | **Raphael 707 Premium Adjusting Table**  
Copyright © 2024 Young Il m All Rights Reserved V1.1

